

Przekroj

Widok sciany meblowej - front

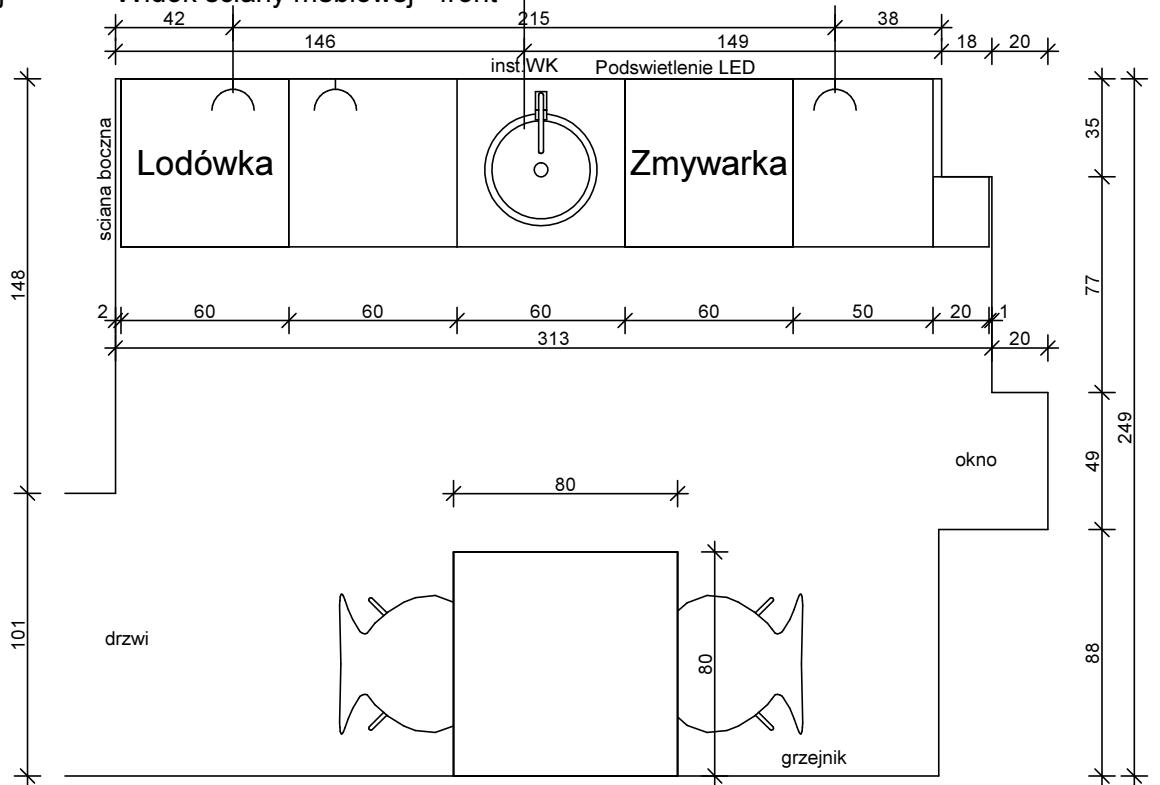

Rzut pomieszczenia.

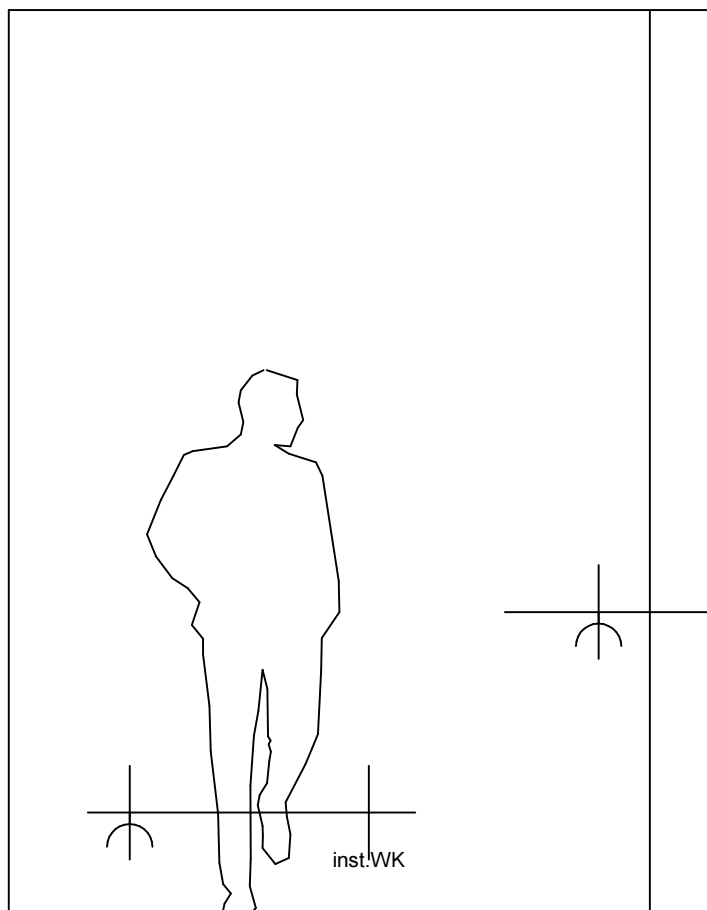
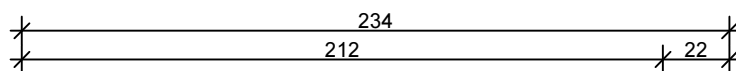

Widok ściany meblowej.

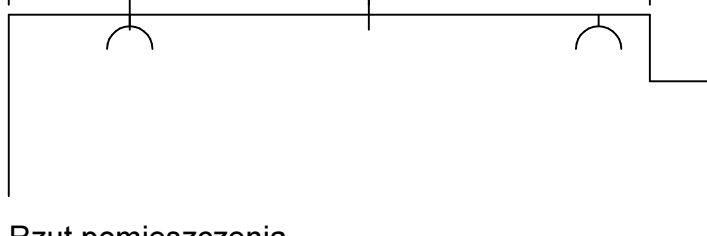
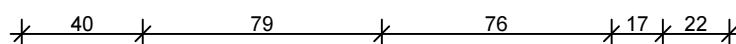

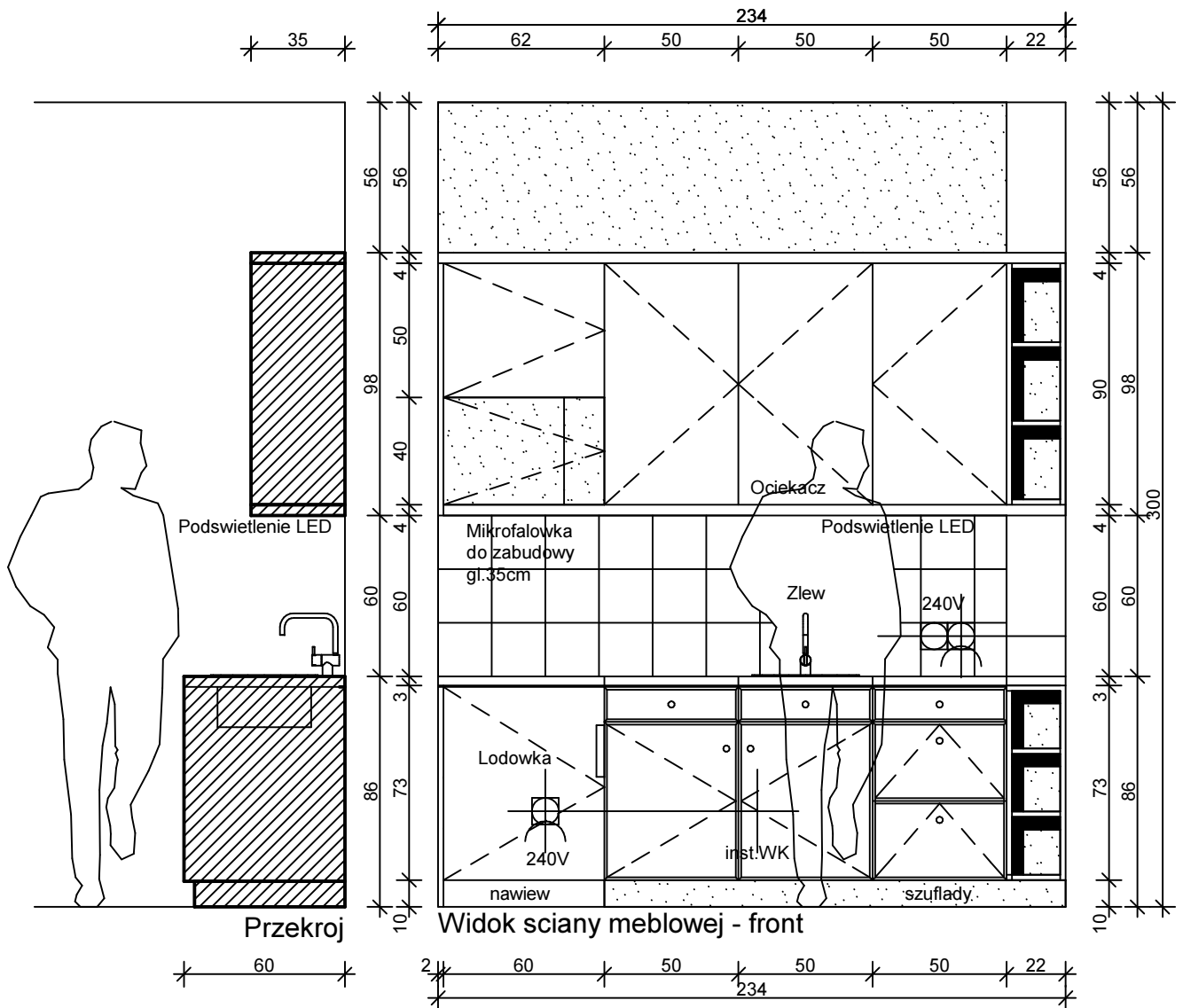

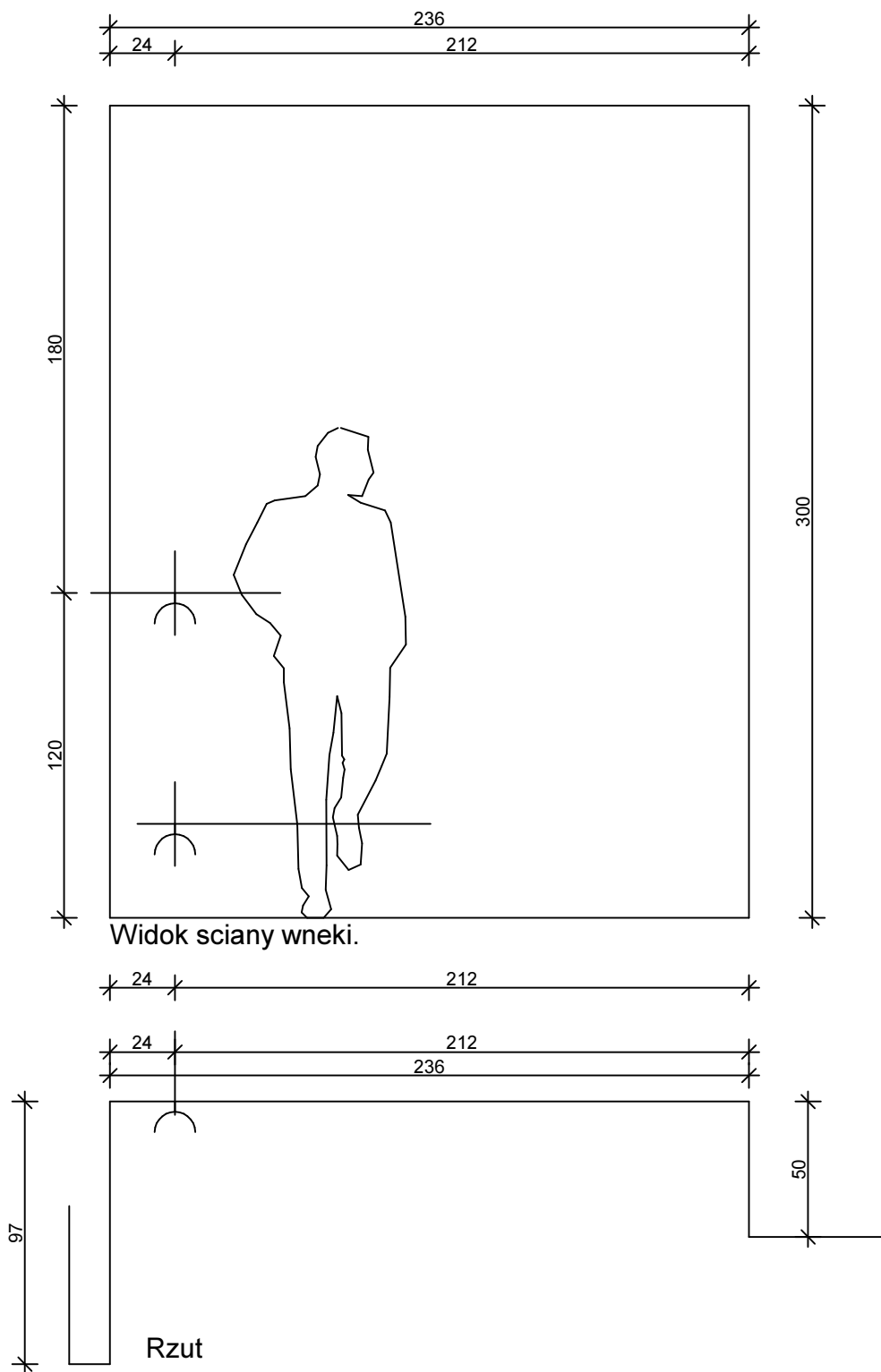

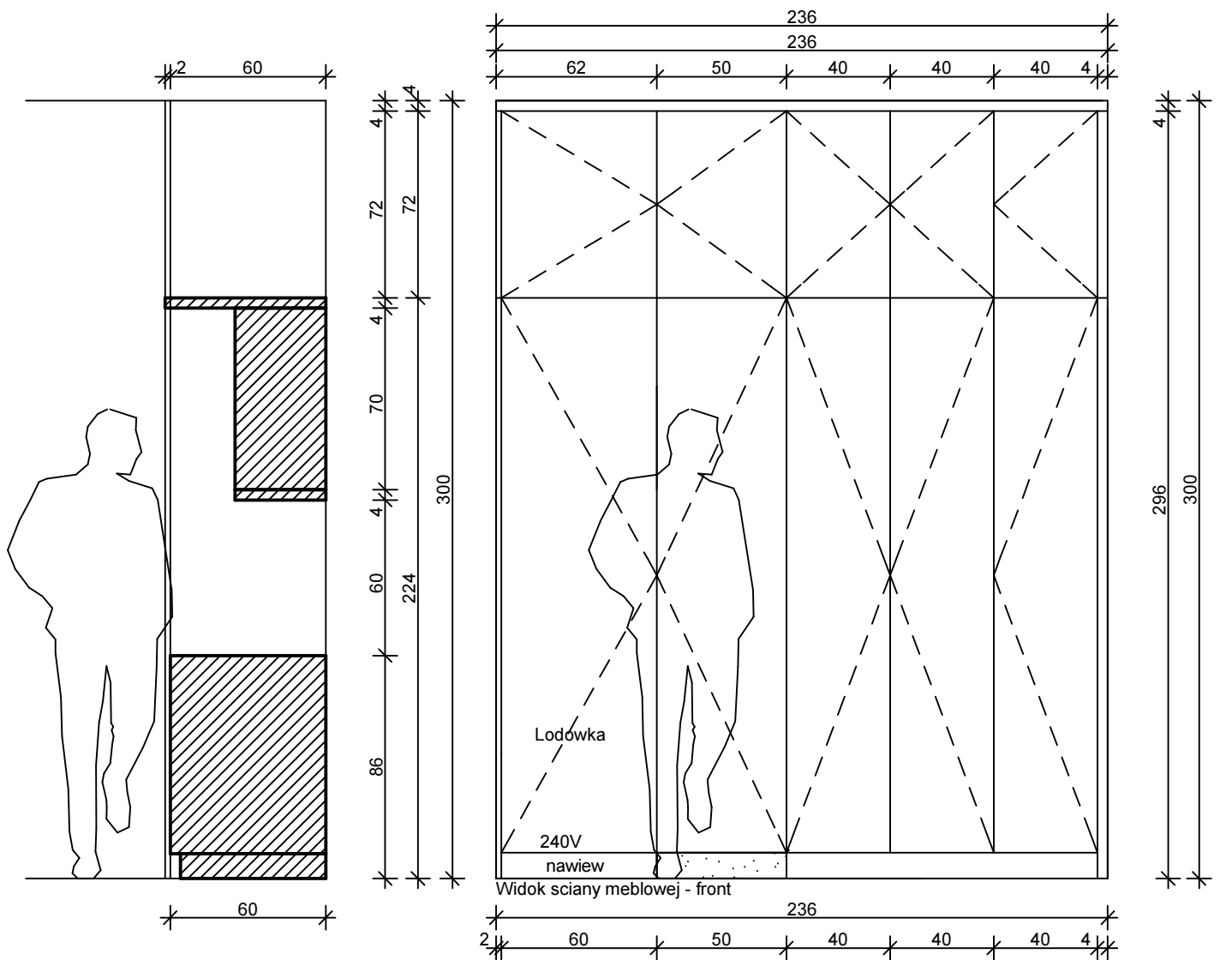

Rzut pomieszczenia.

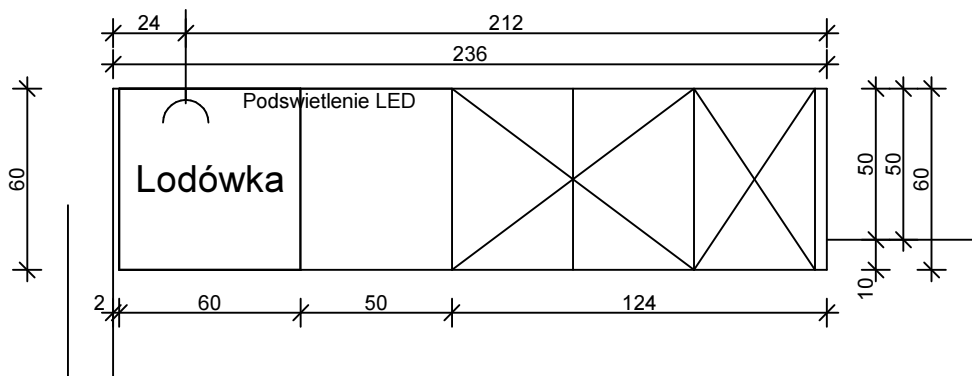

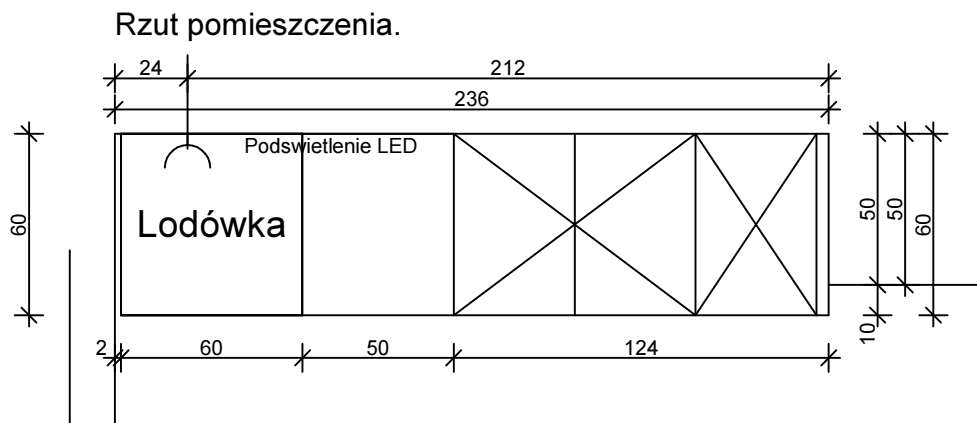
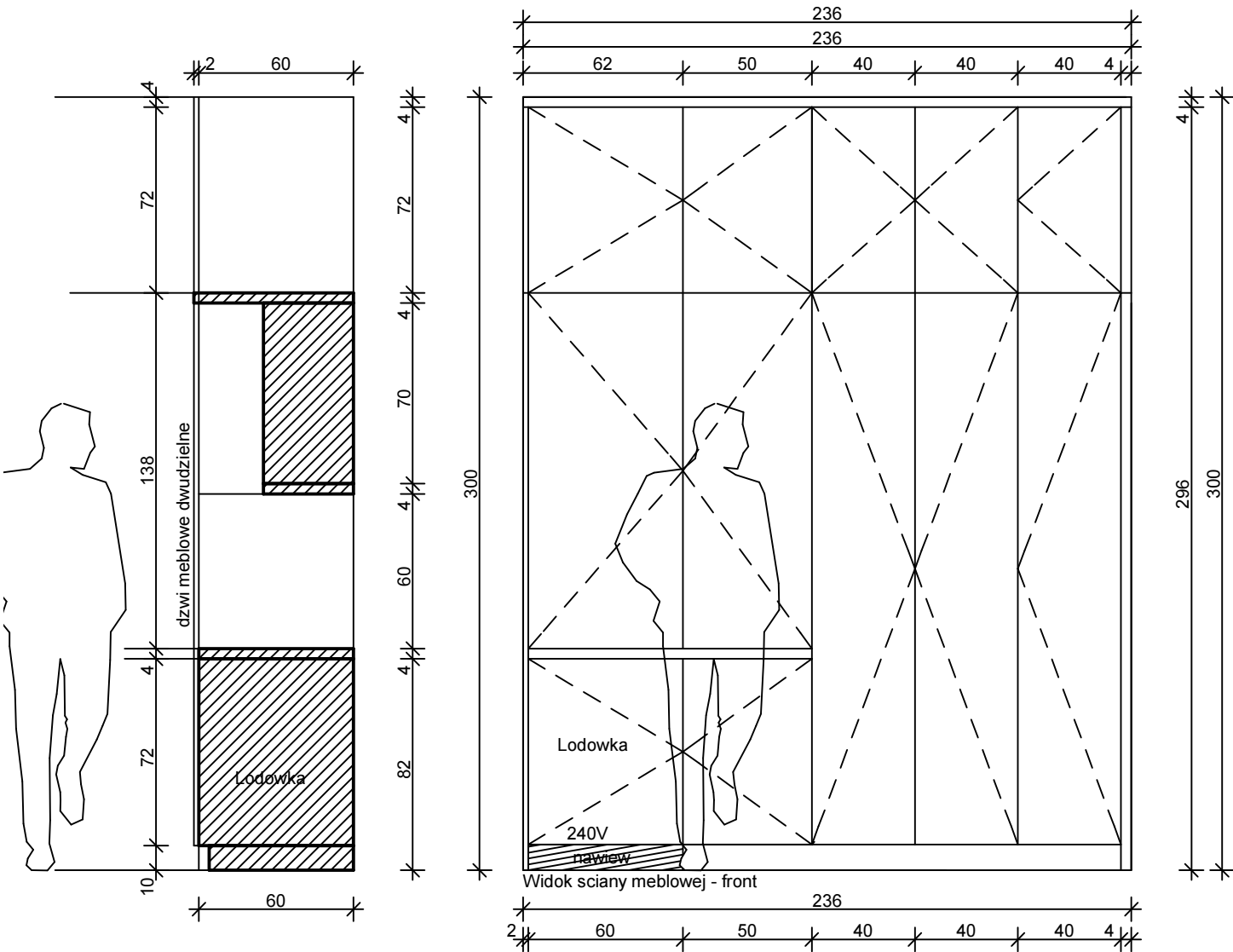

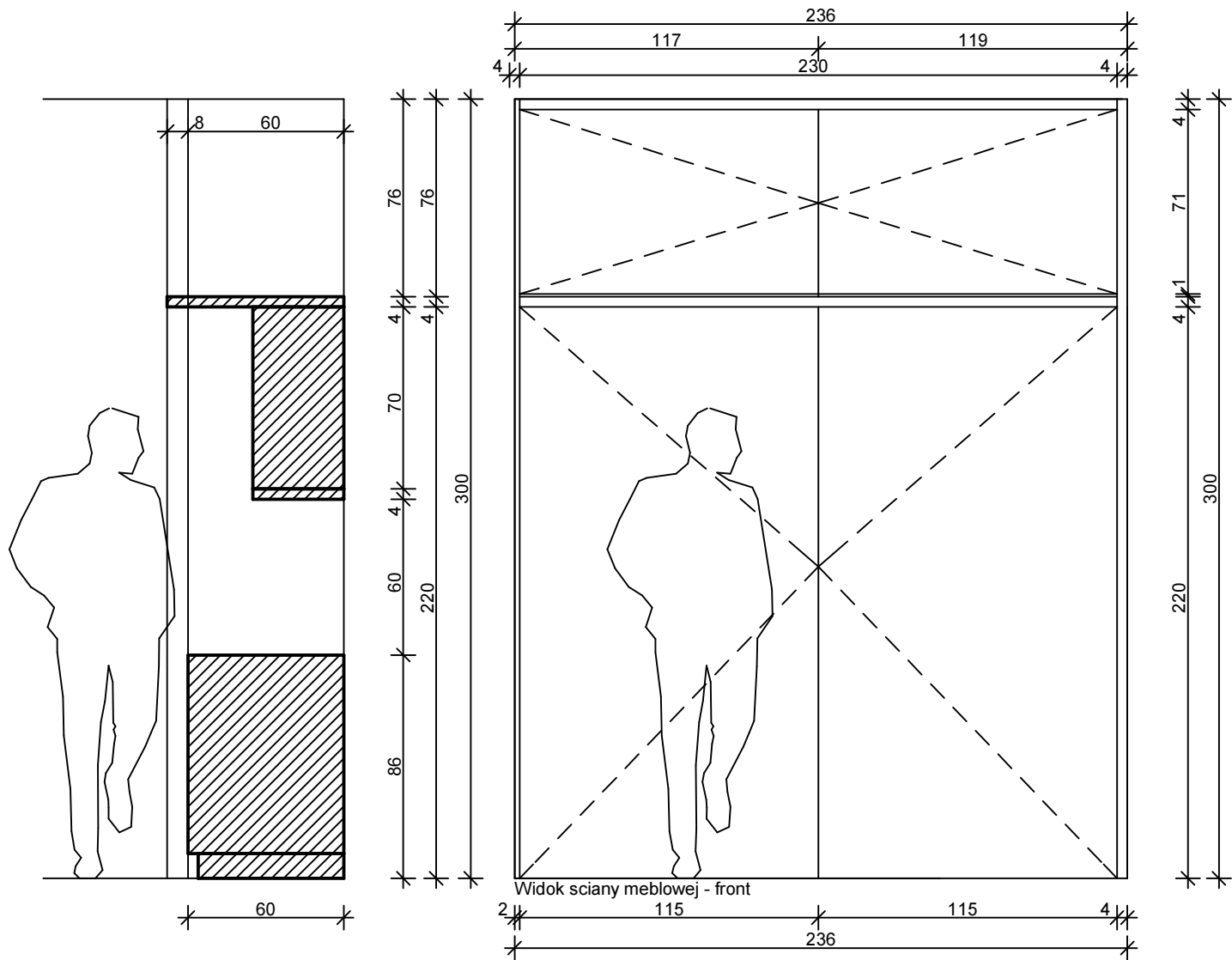

Rzut pomieszczenia.

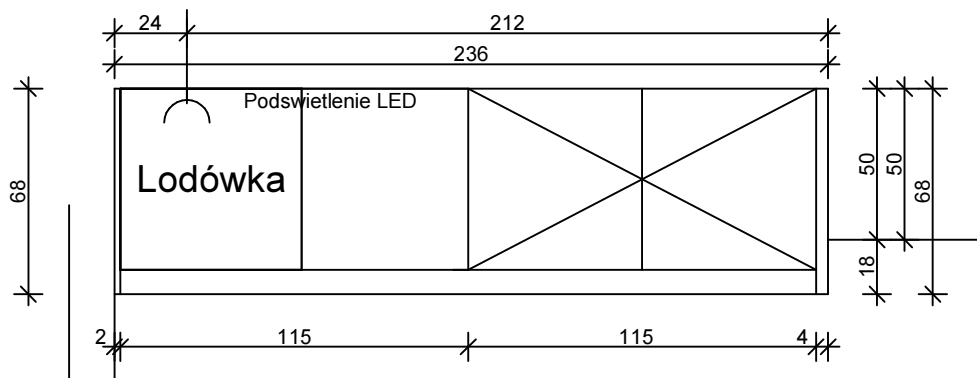

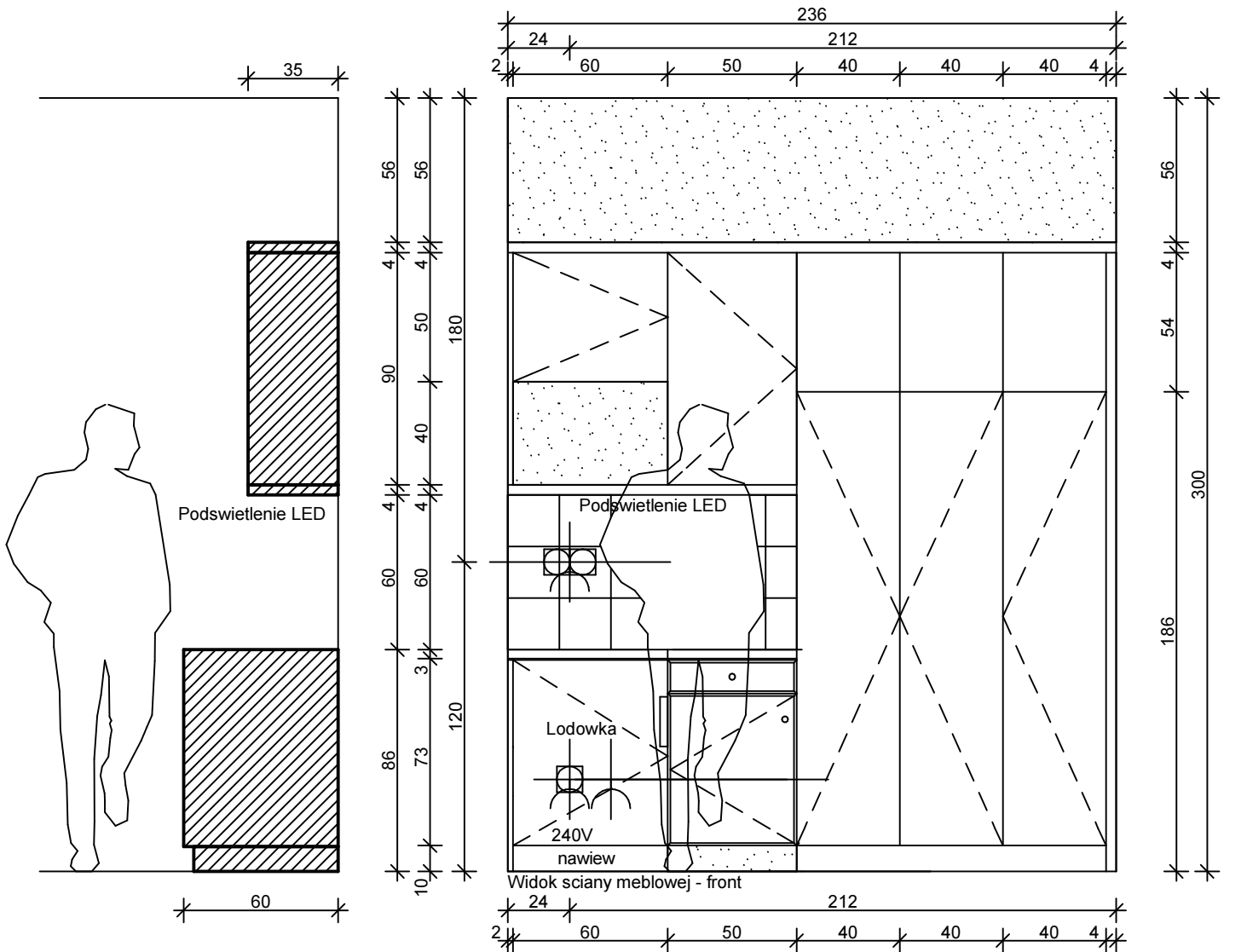

Rzut pomieszczenia.

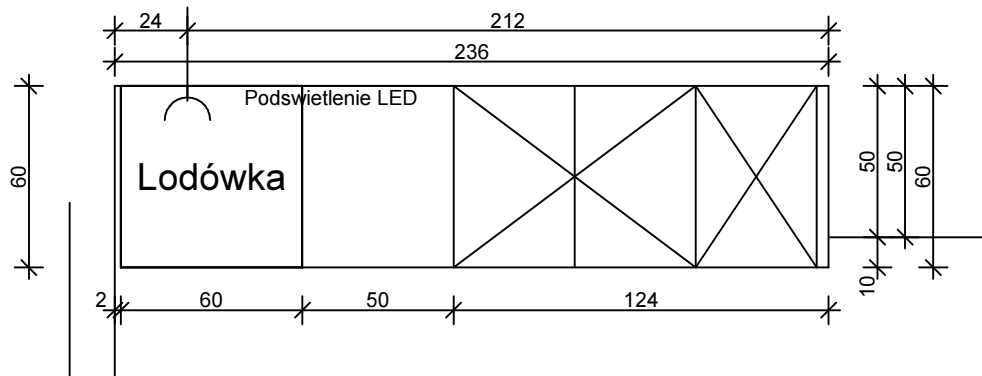

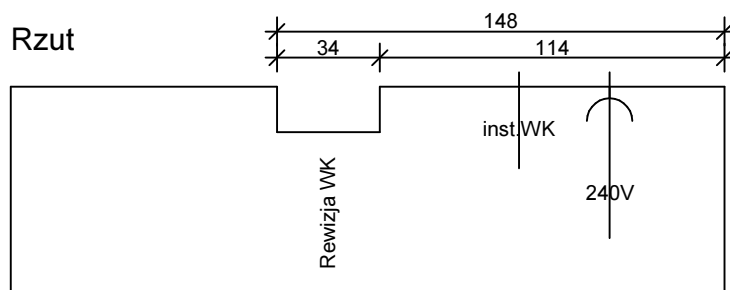
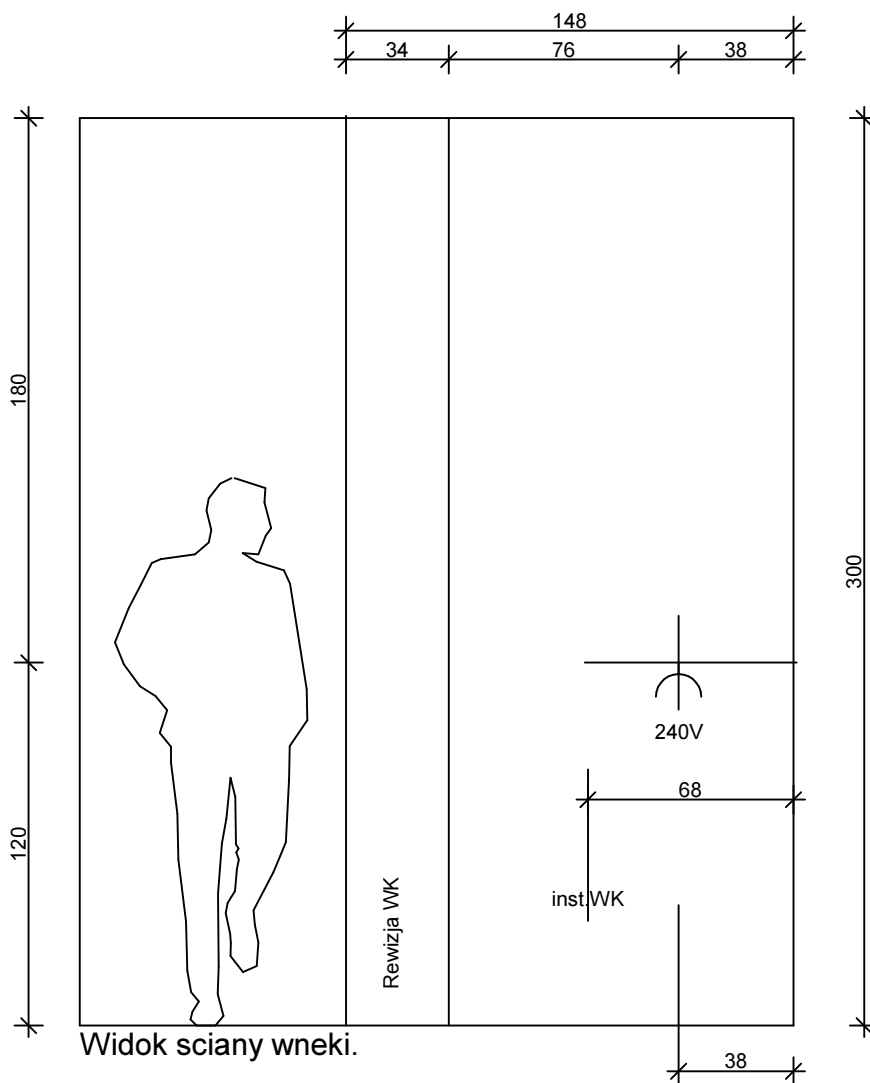

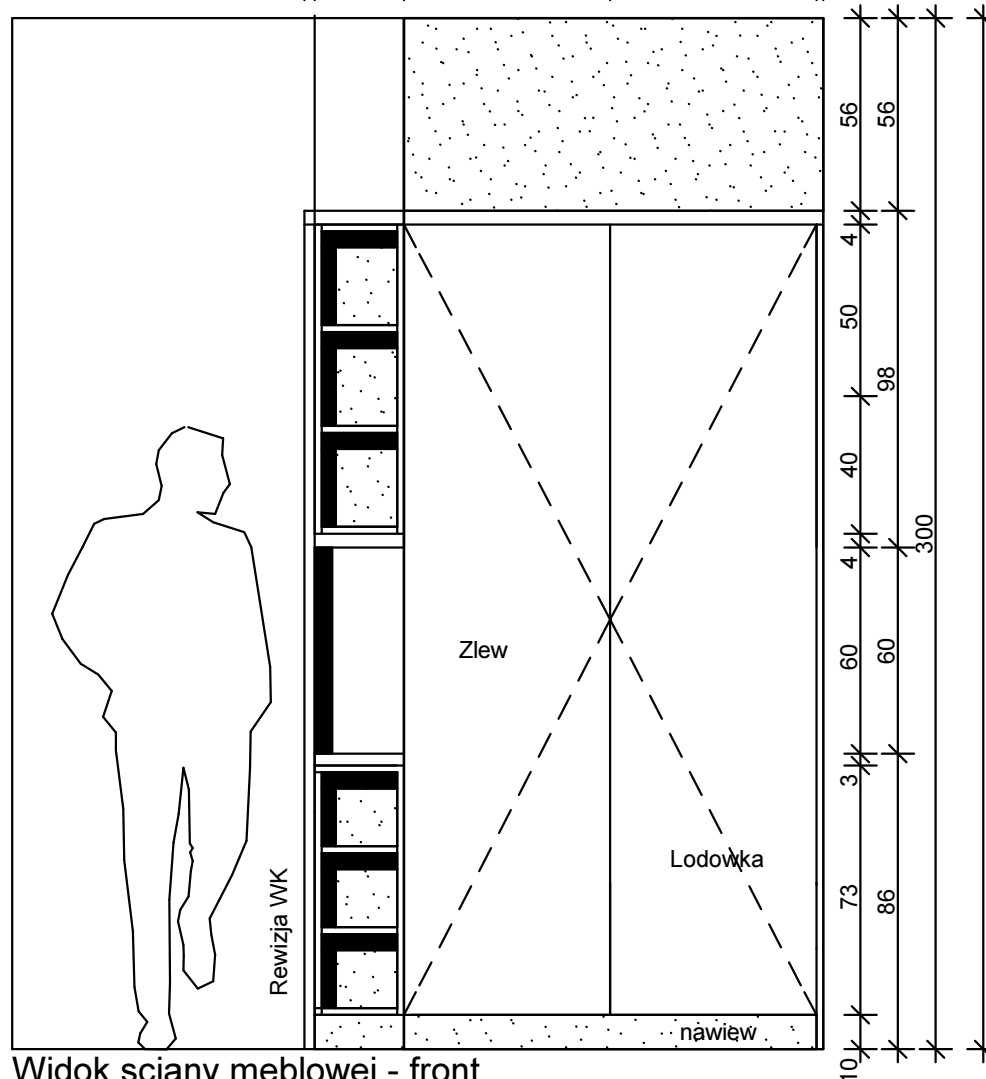
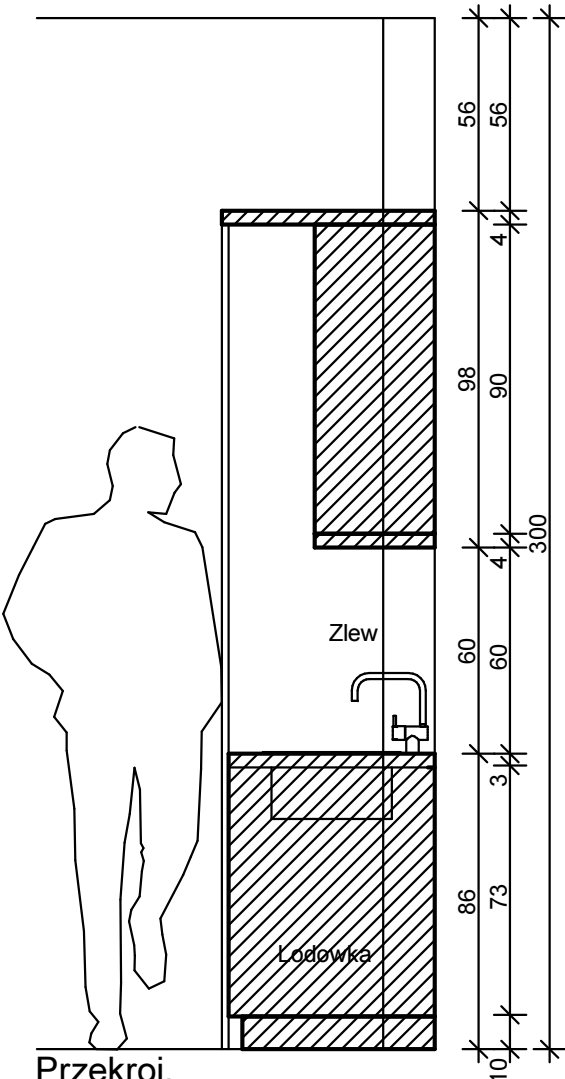
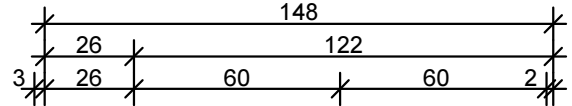
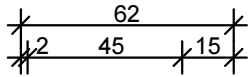

Przekroj.

Widok sciany meblowej - front

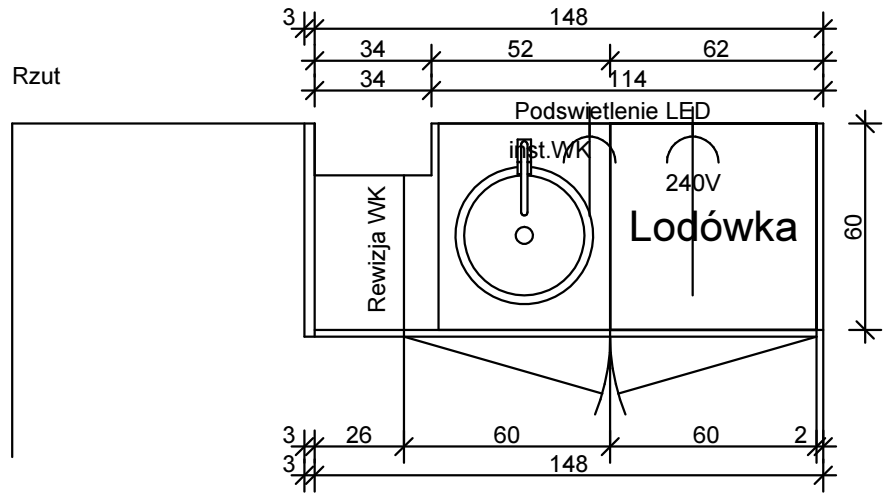
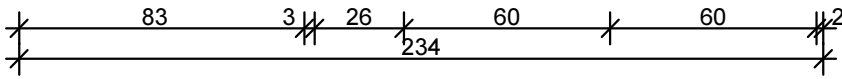
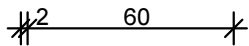

Rzut

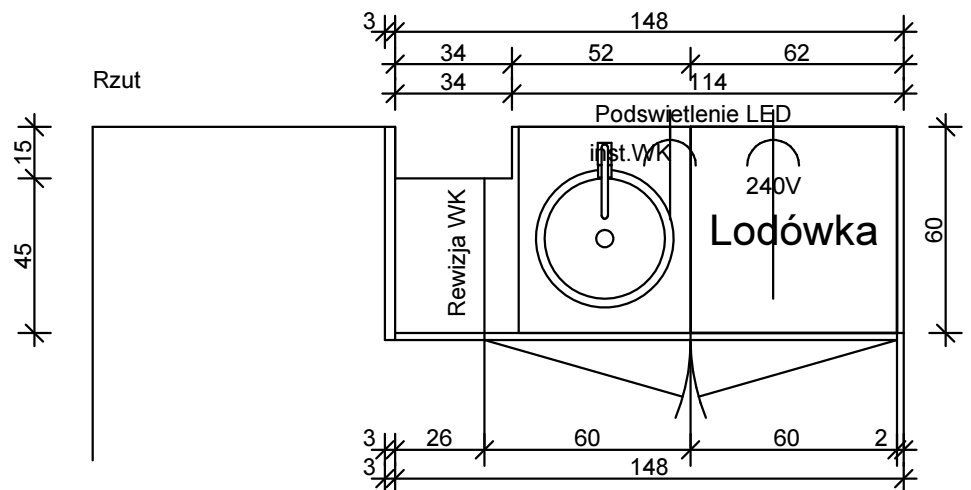
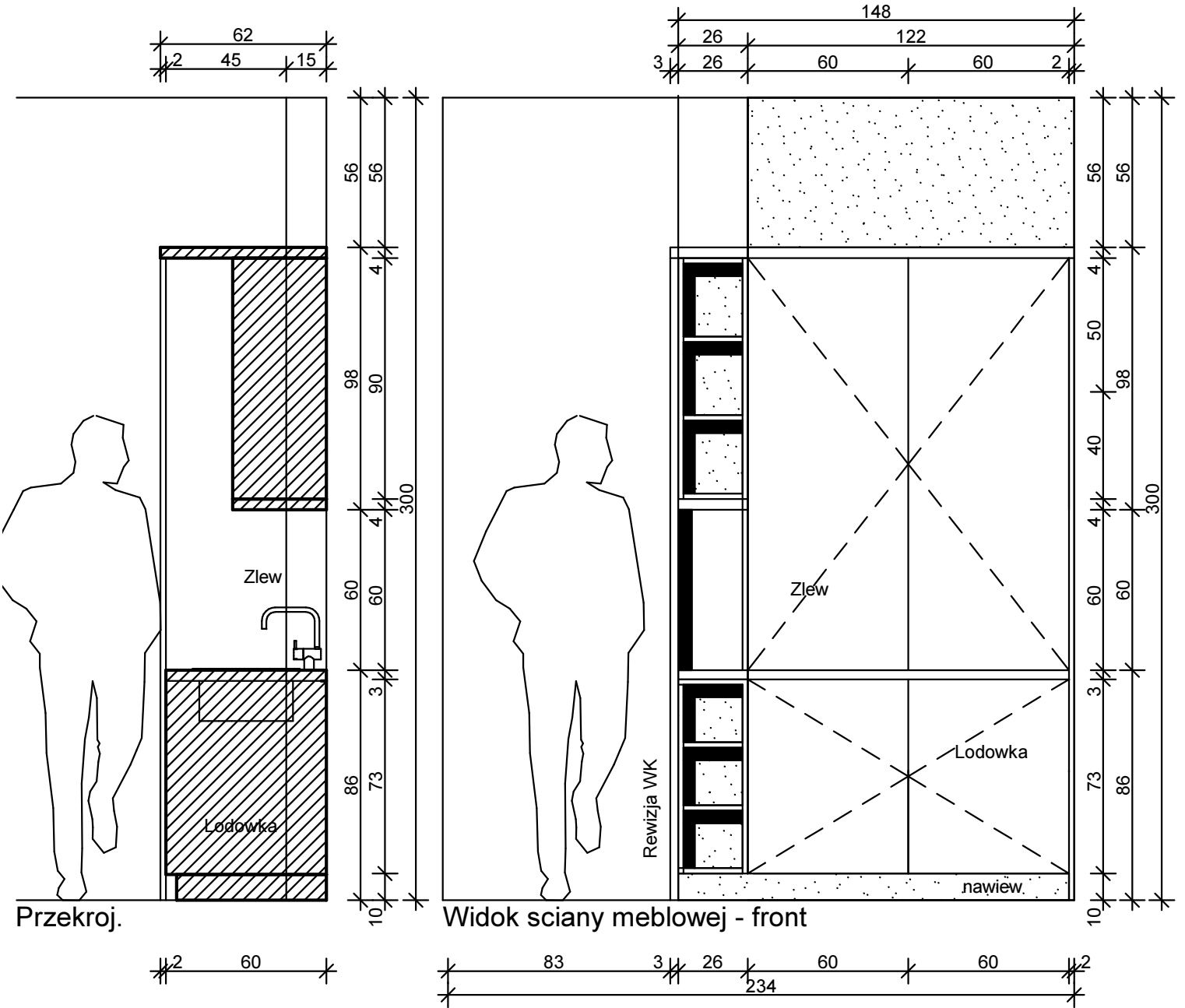

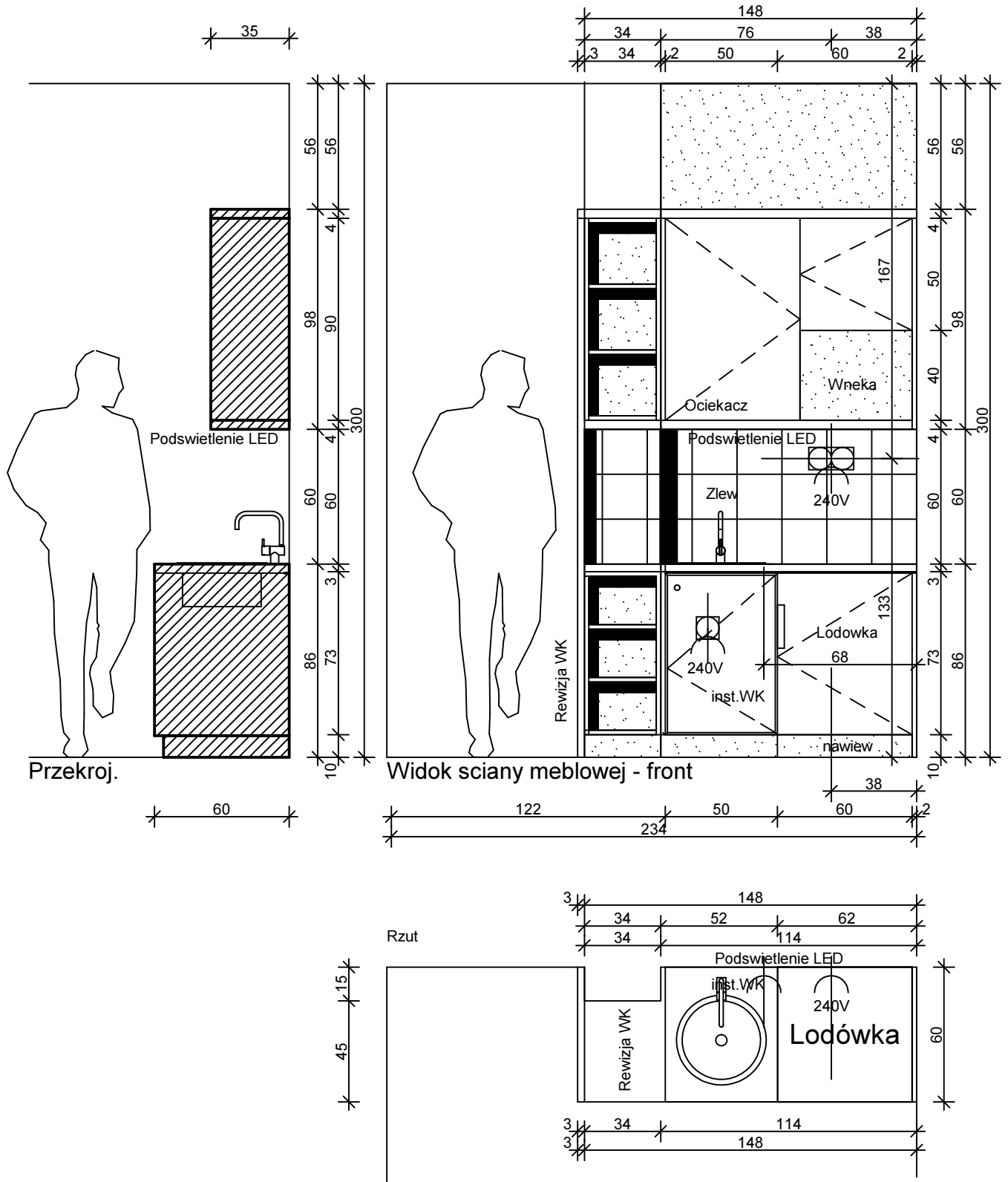

Aneks kuchenny Nr4. Sekretariat biura Kwestora.

Projekt mebla.

19.12.2014r

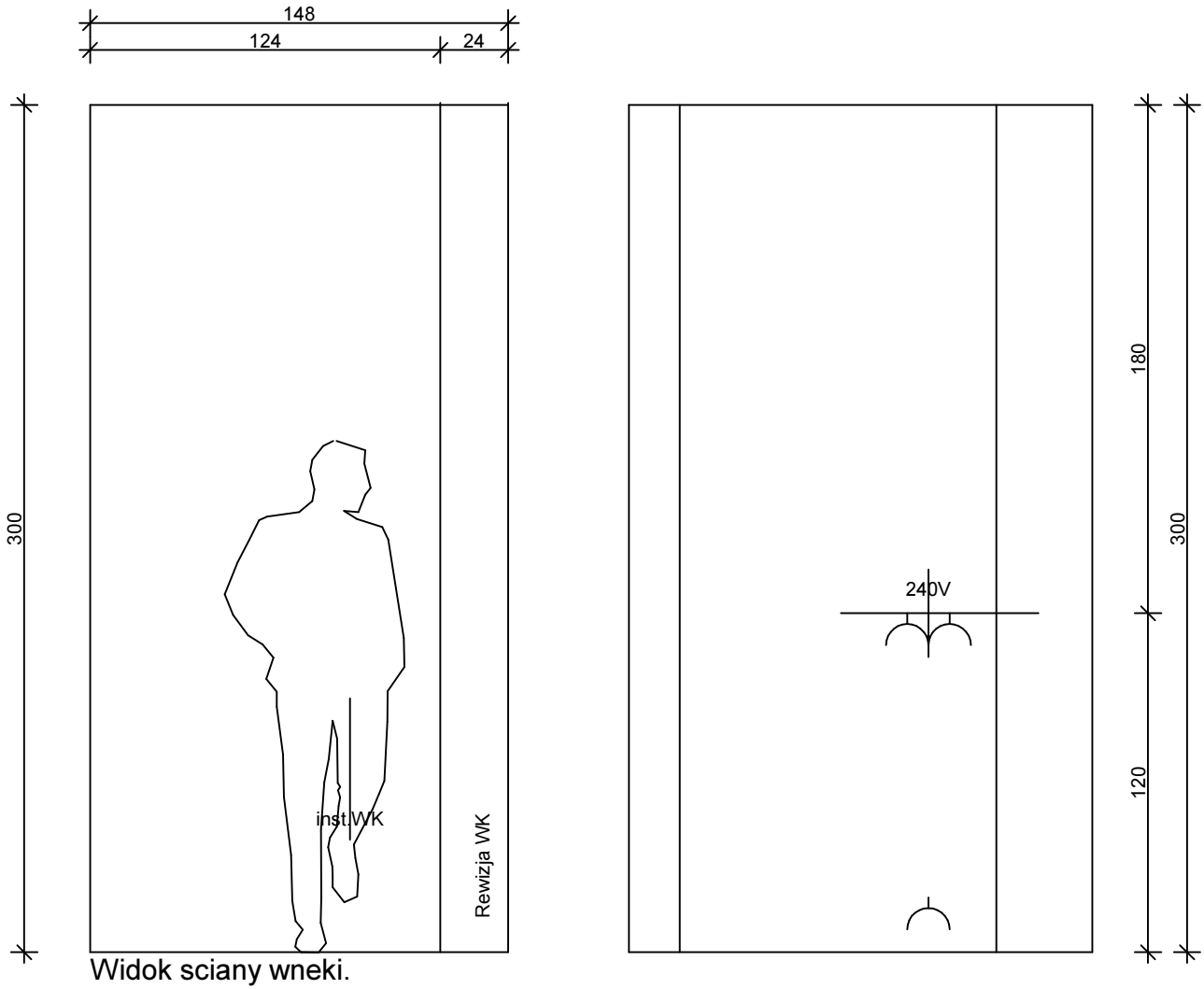

Rzut

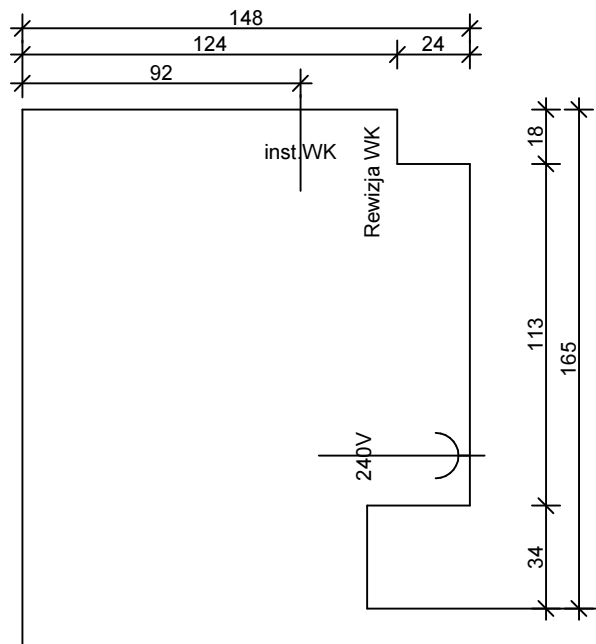

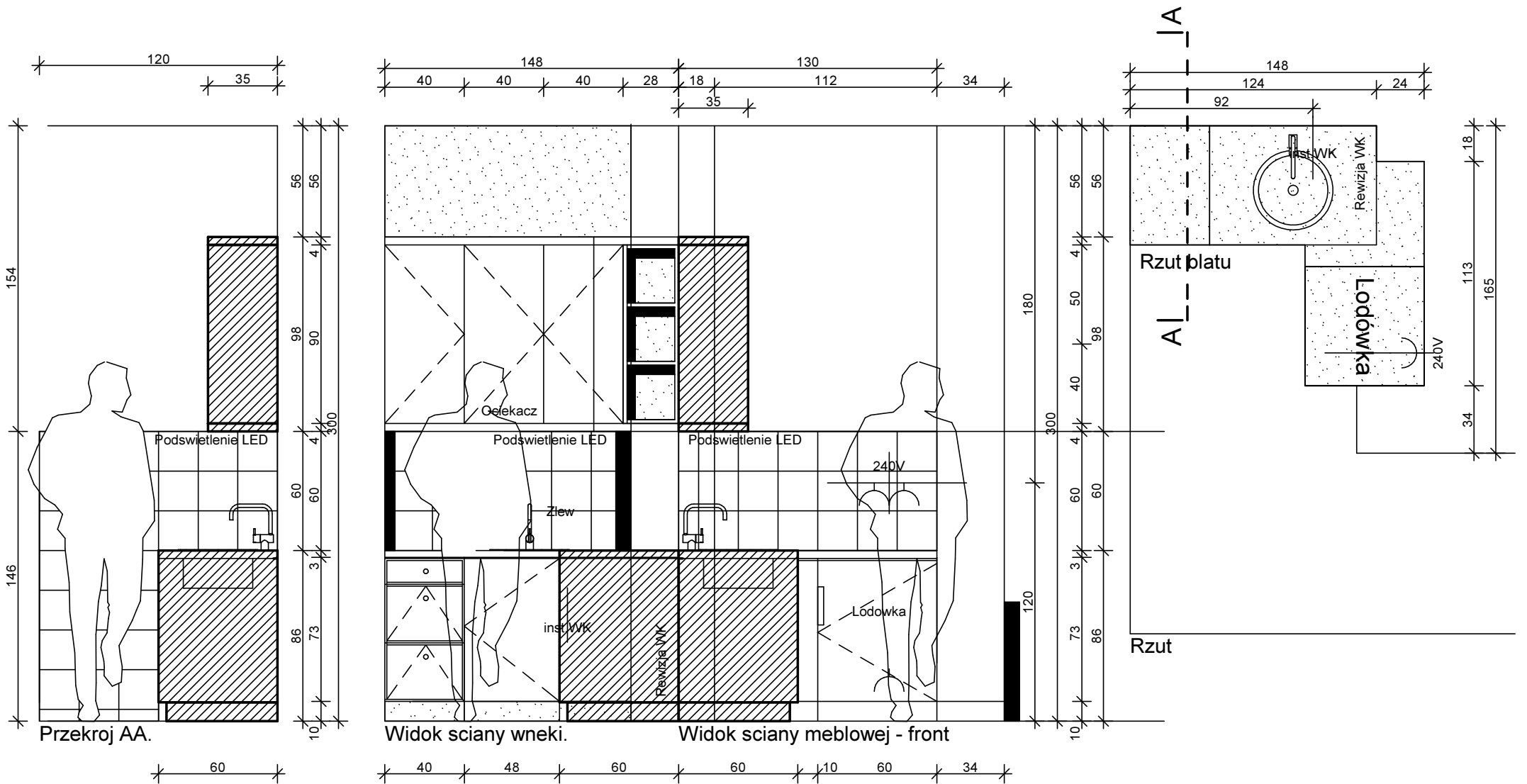

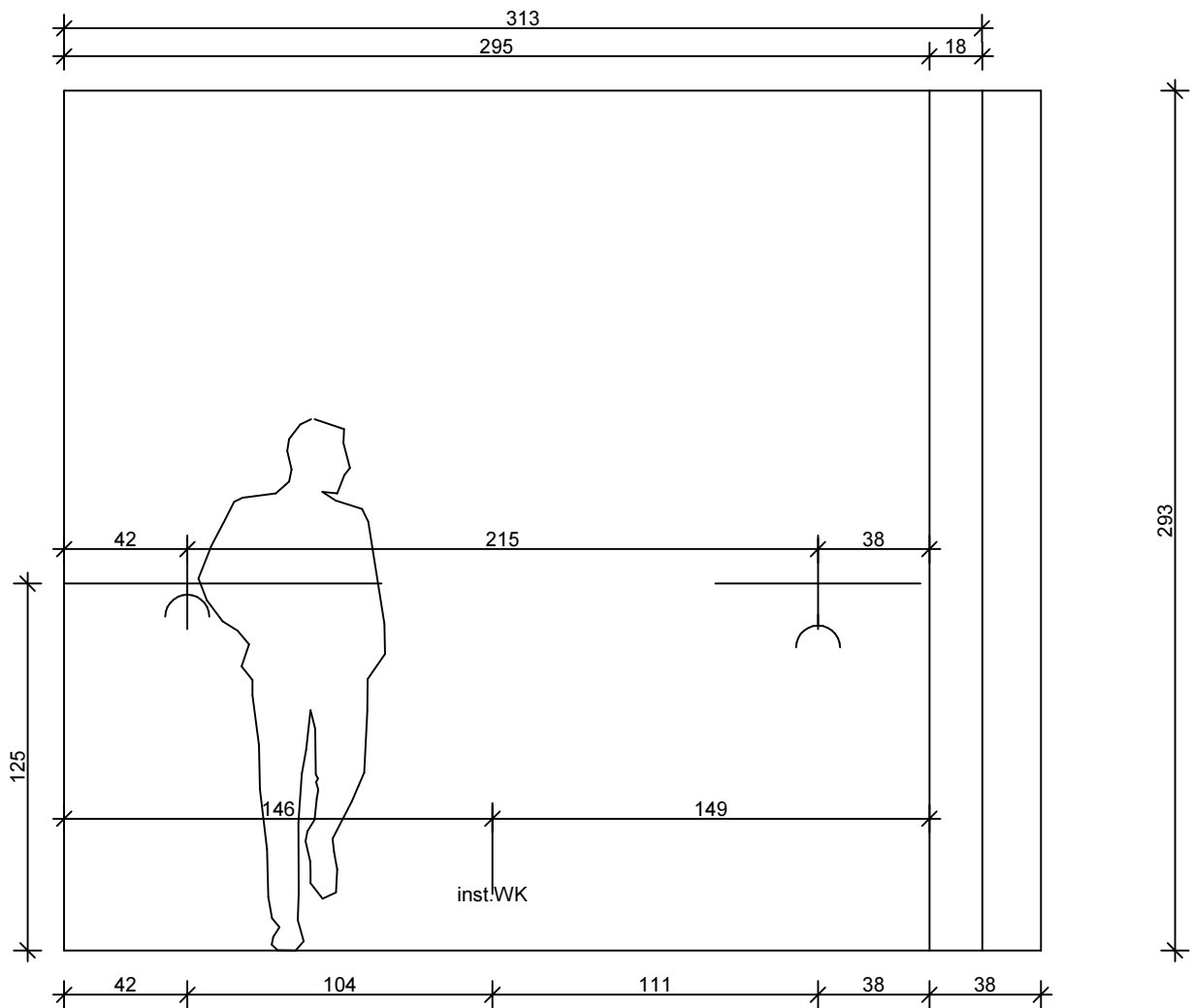

Widok sciany meblowej.

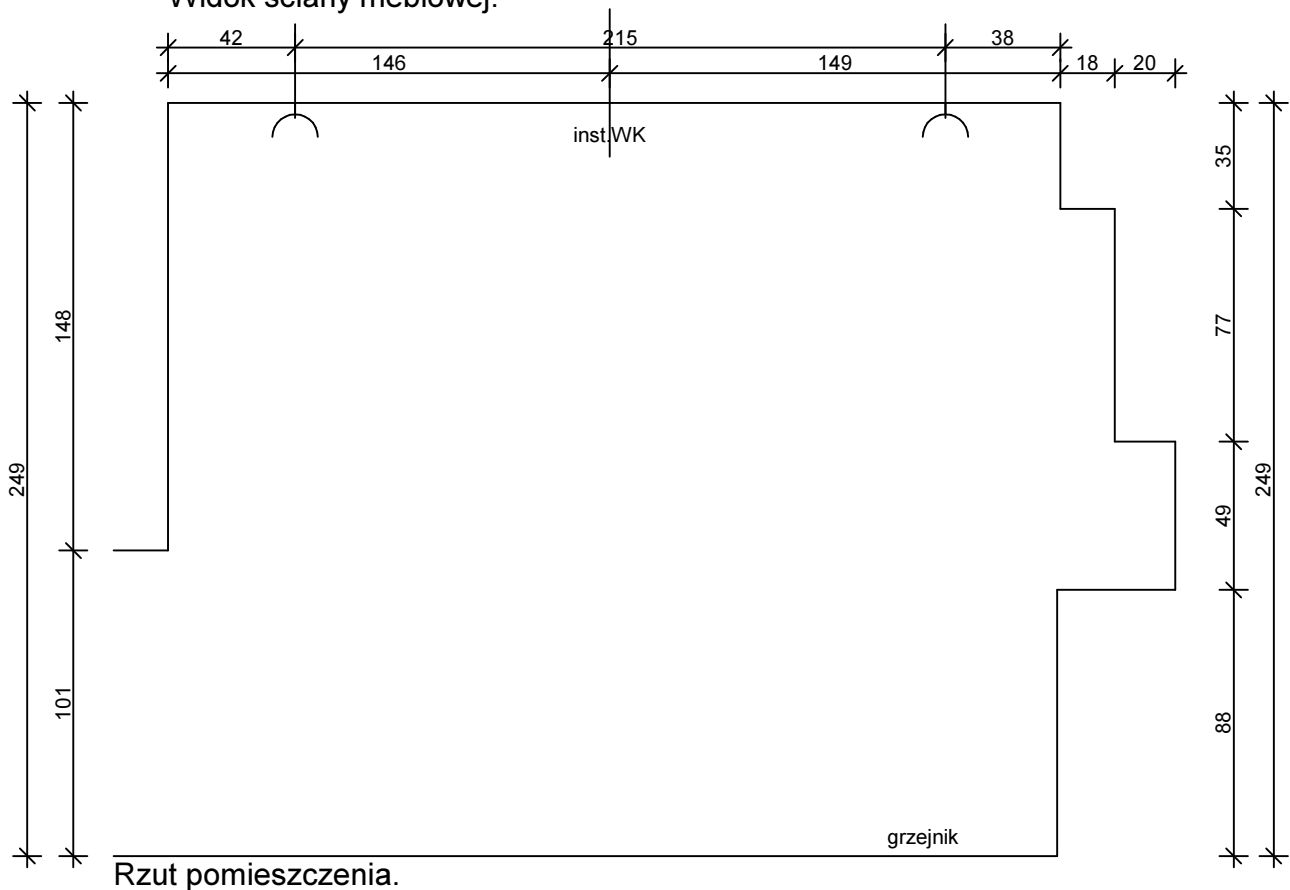

Rzut pomieszczenia.

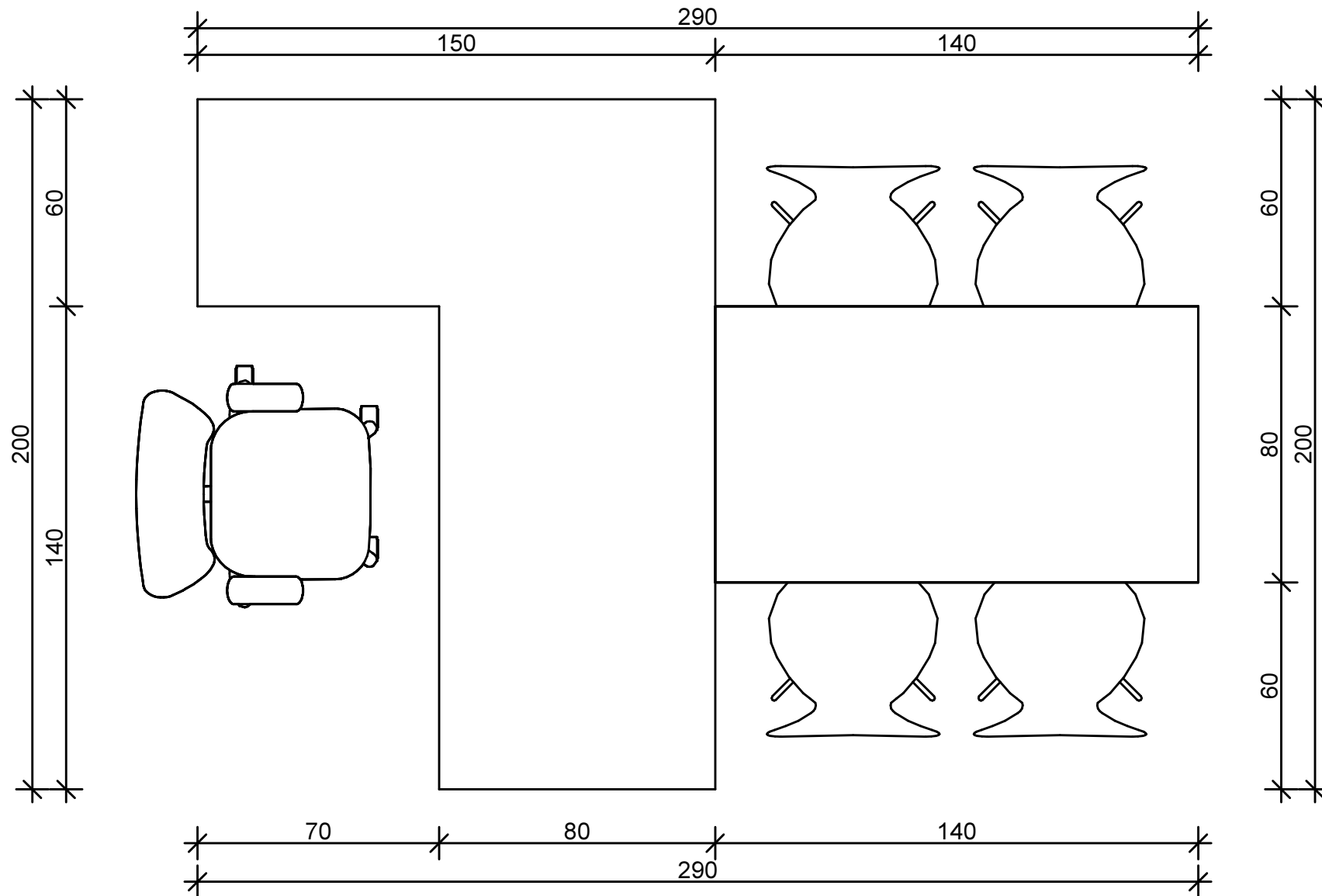

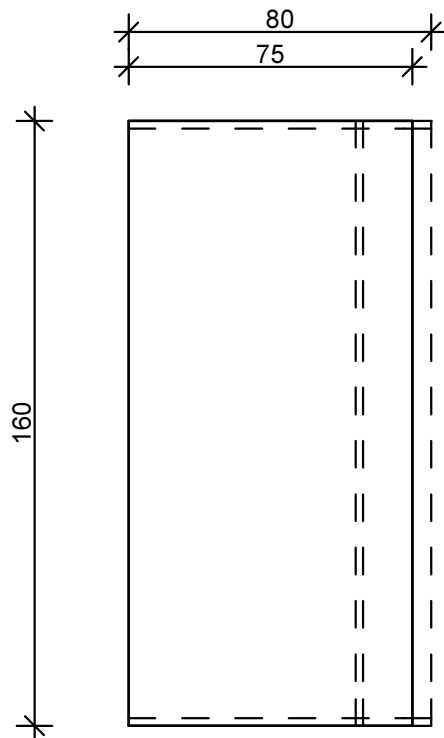

Bierko prostokątne
Rzut z góry

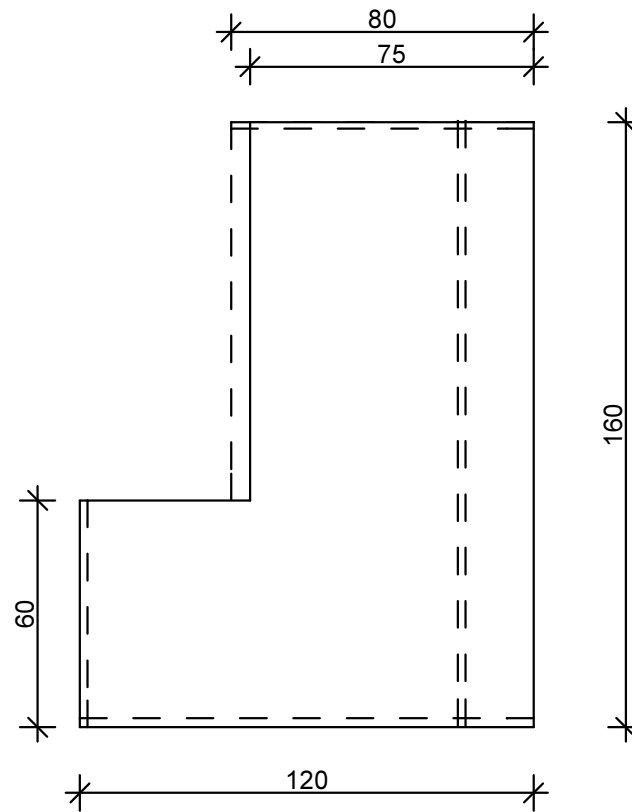

Bierko prostokątne narożne
Rzut z góry

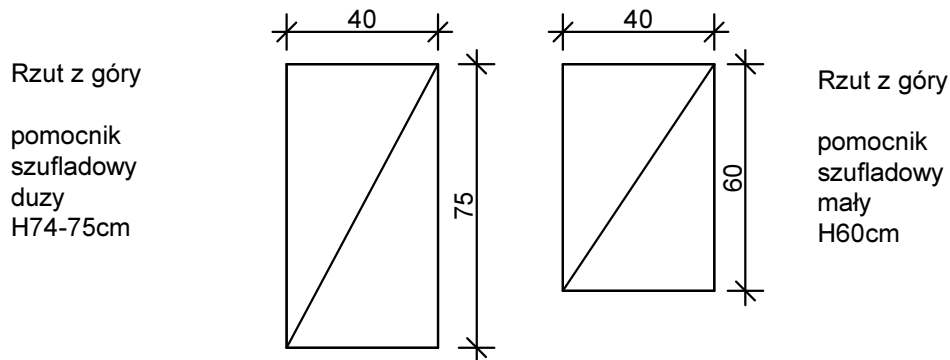
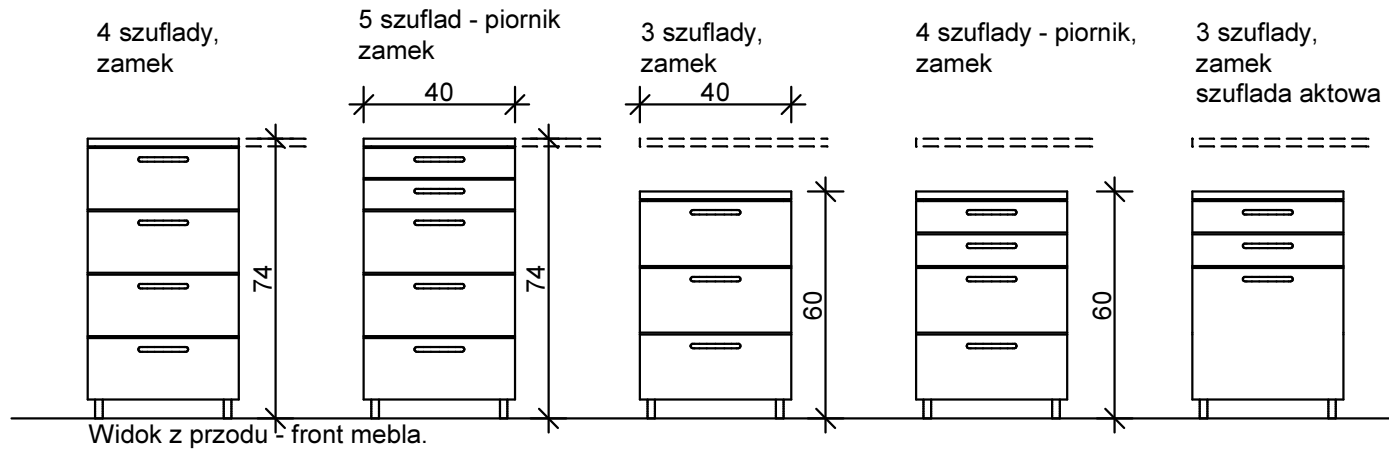

Pomocnik z szufladami.

Projekt mebla.

19.12.2014r

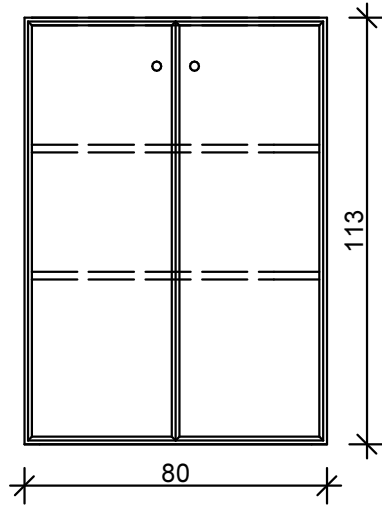

3 poziomy drzwi pelne

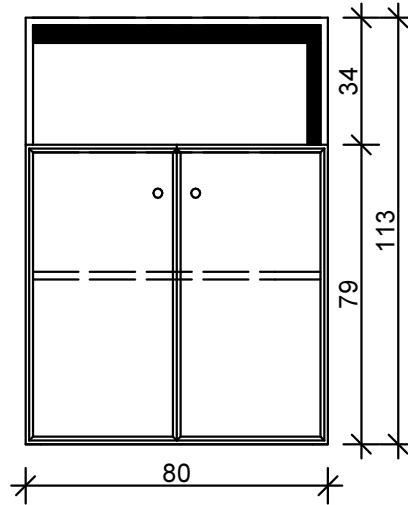
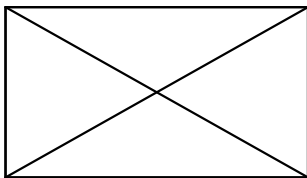

3 poziomy
1 poziom otwarty
drzwi pelne

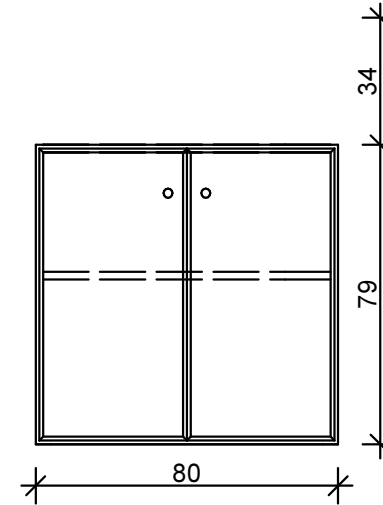
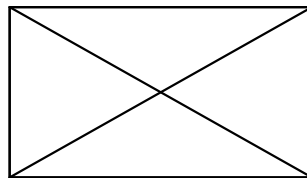

2 poziomy drzwi pelne

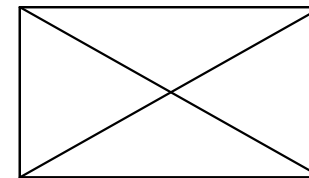

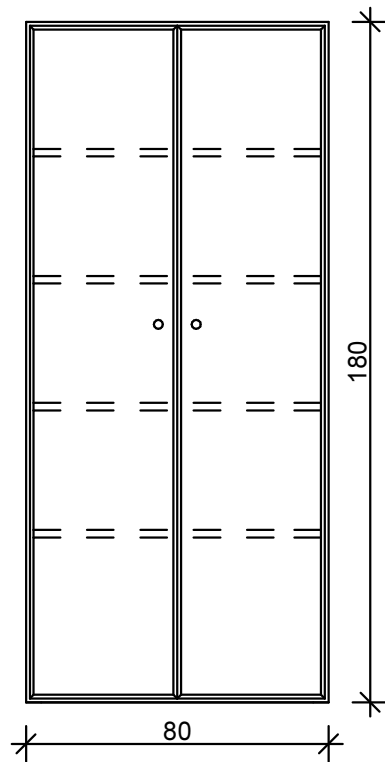

5 poziomow drzwi pelne

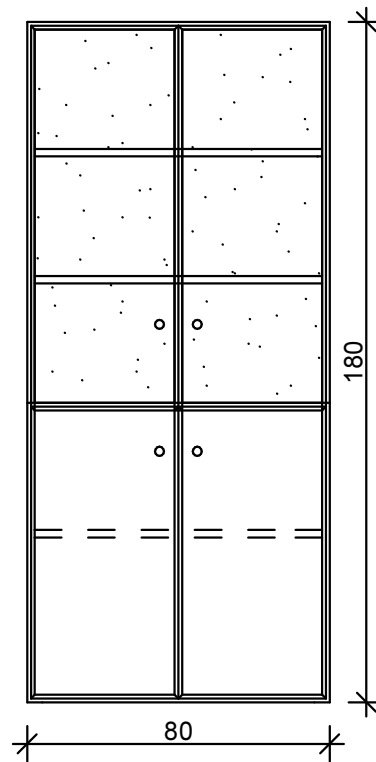
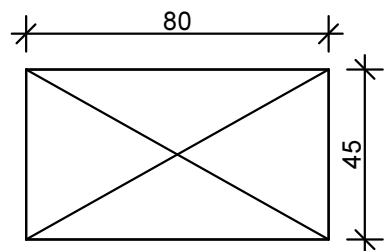

5 poziomow
drzwi przeszkłone 3 poziomy
drzwi pelne 2 poziomy

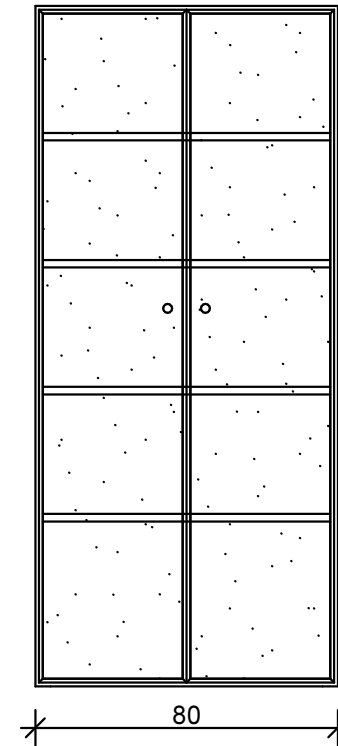
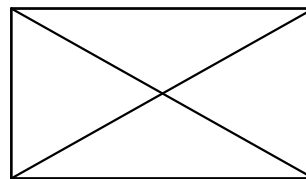

5 poziomow drzwi przeszkłone

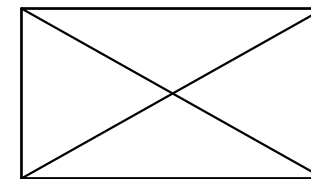

Projekt mebla.

Szafy biurowe wysokie dwupoziomowe. Archiwa.

Rzut z góry

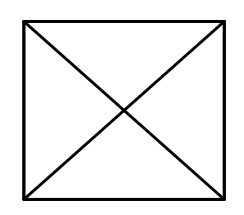
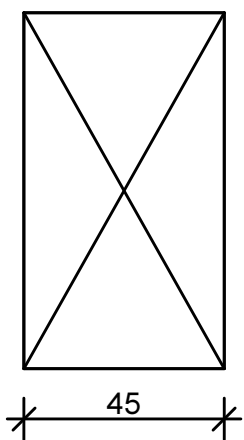
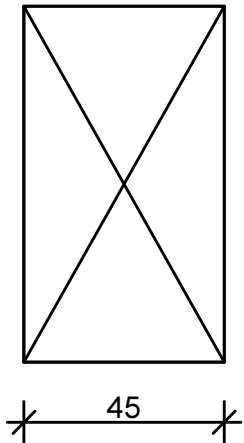

Widok z przodu - front

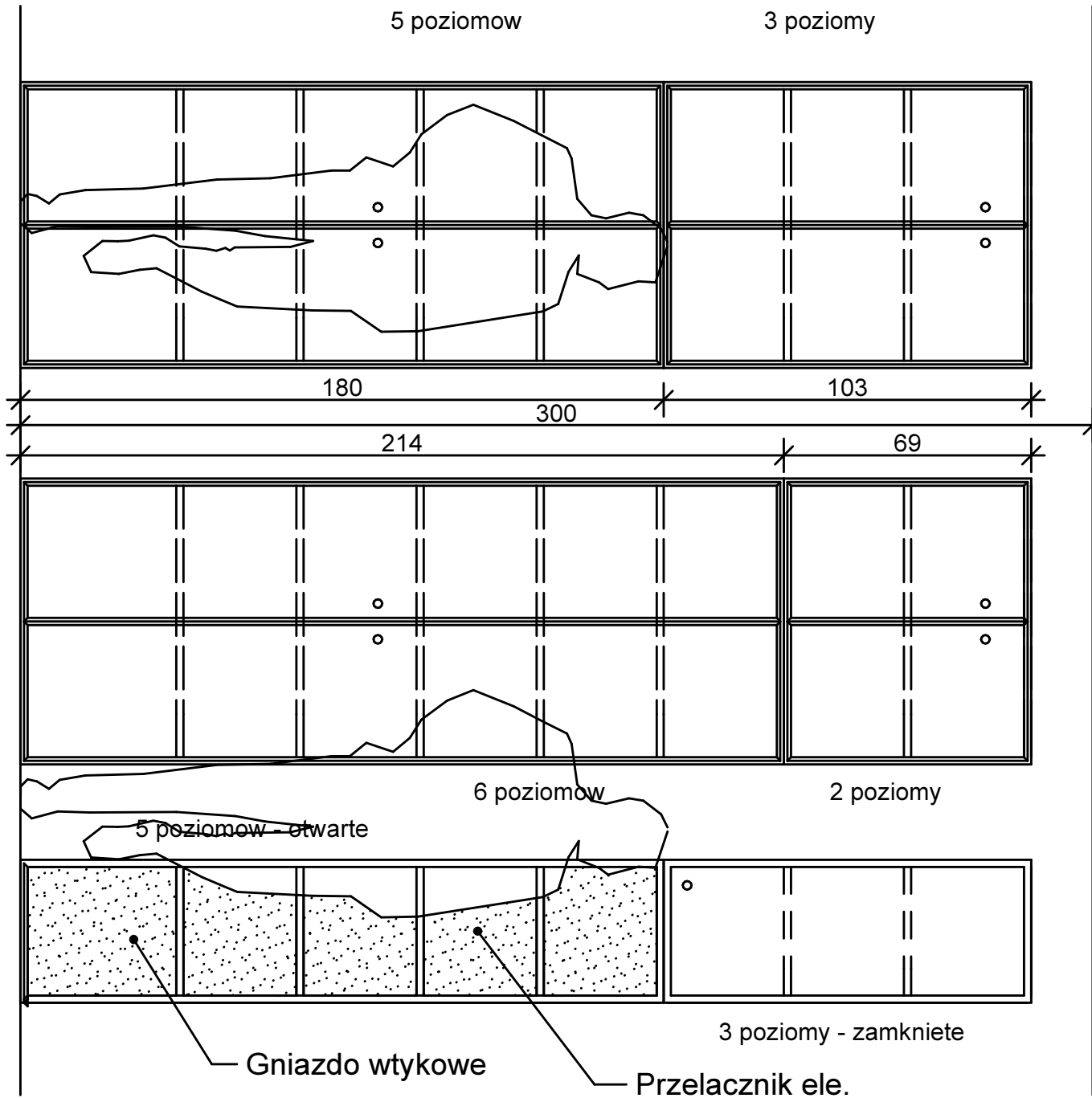

19.12.2014r

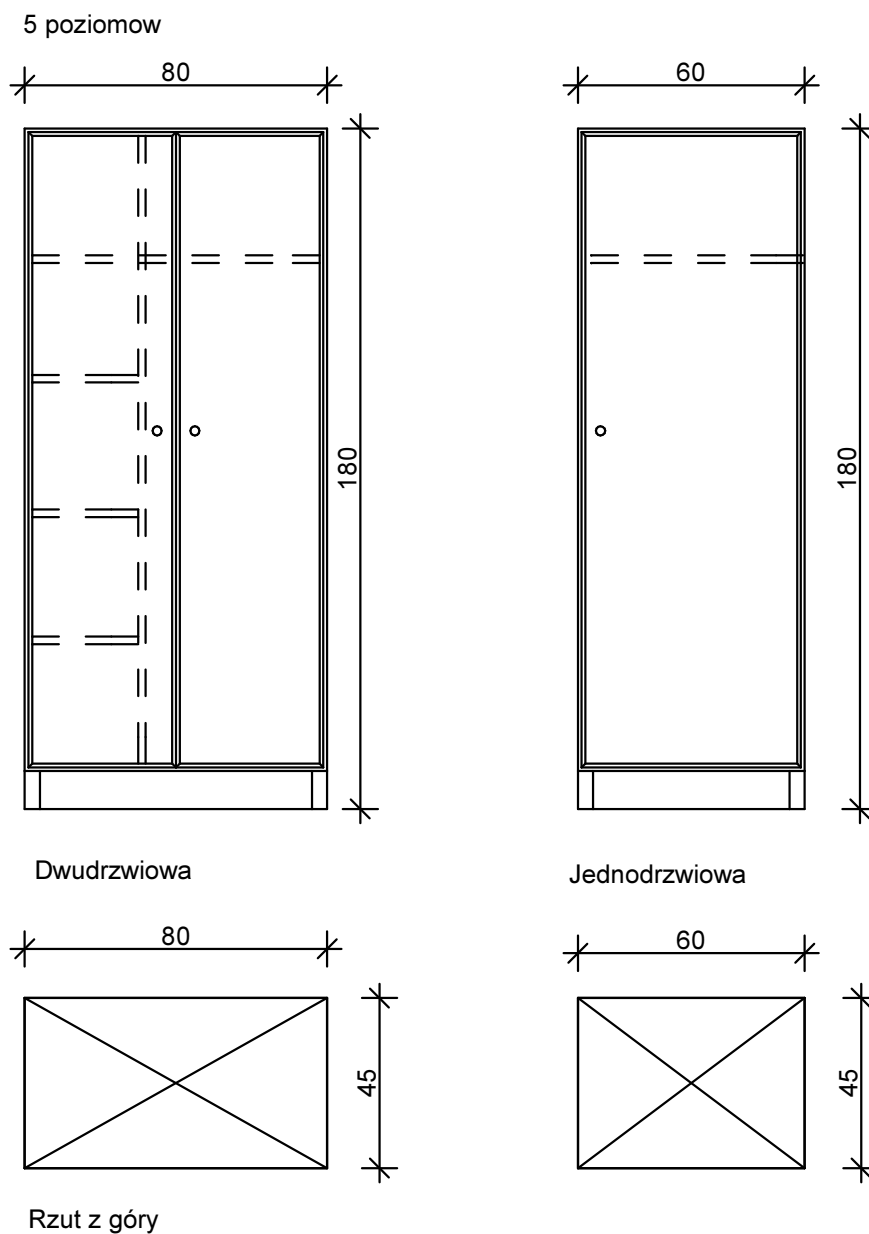

Szafy biurowe ubraniowe wg systemu. Szerokosc 80cm i 60cm

Projekt mebla.

19.12.2014r